

1 2 3 4 5 6

A
B
C
D

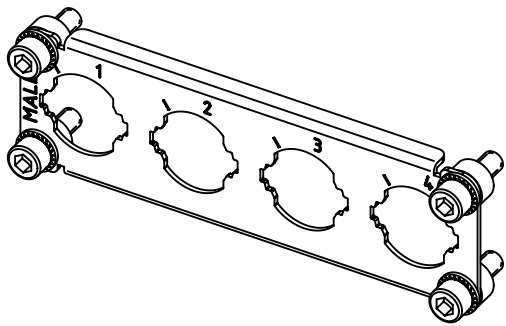
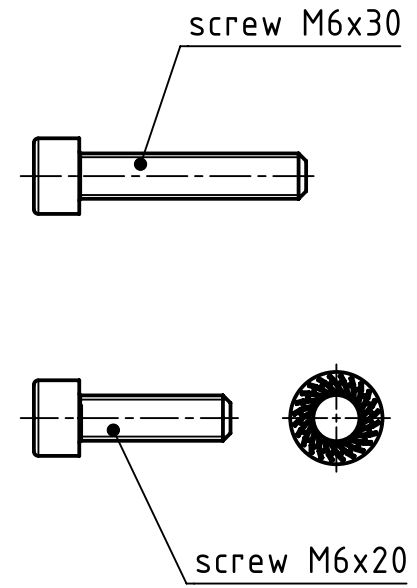
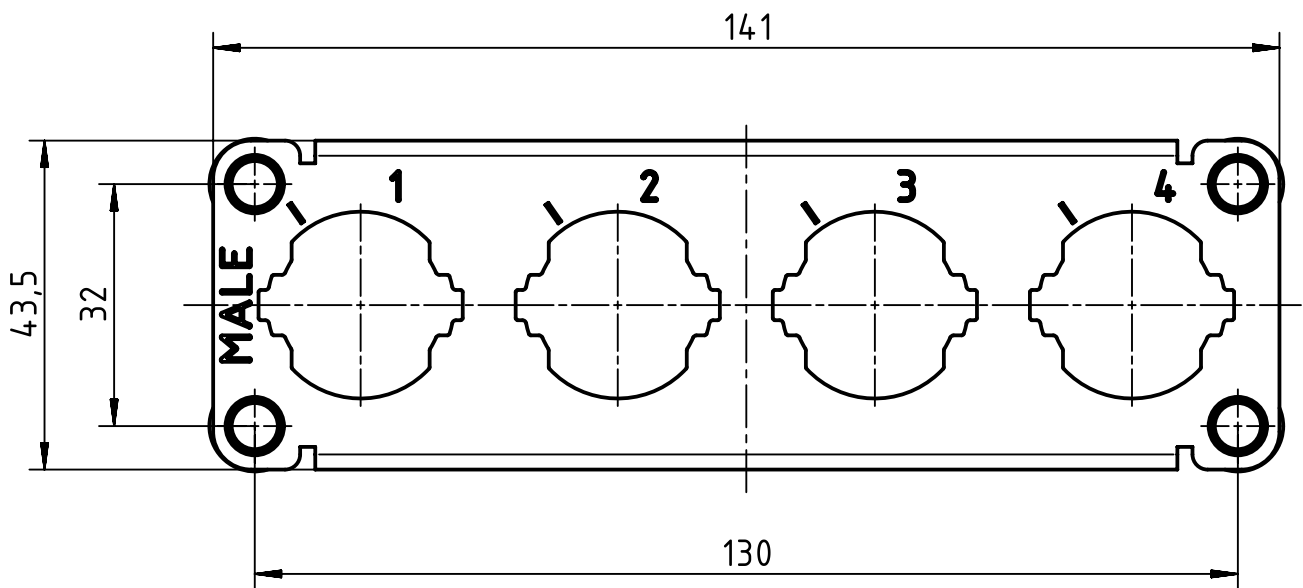

	All Dimensions in mm Original Size DIN A4		Scale 1:1	Free size tol.		Ref.	
						Sub.	
	All rights reserved Department EL PD - DE		Created by RULLKOETTER	Inspected by SUNDERMEIER	Standardisation TIEMANNA	Date 2014-07-30	State Final Release
	HARTING Electric GmbH & Co. KG D-32339 Espelkamp		Title Han 4HC-frame enlarged 250-male			Doc-Key / ECM-Nr. 100587135/UGD/001/A 500000078358	
			Type TB	Number 09 11 000 9927		Rev. A	Page 1/1