

SIRIUS safety relay Basic unit 3SK2 series 20 F-DI, 4 F-DQ, 2 DQ, 24 V DC Can be parameterized via SIRIUS Safety ES 45 mm width screw terminal up to SILCL 3 (DIN EN 62061) Up to Performance Level E (ISO 13849-1) Output expansions 3SK1 and fail-safe motor starters 3RM1 via device connector connectable



Figure similar

Product brand name	SIRIUS
Product category	Safety relay
Product designation	Base-Unit

### General technical data

Product function	
• EMERGENCY STOP function	Yes
• protective door monitoring	Yes
• protective door monitoring with tumbler	Yes
• muting, 2 sensor-parallel	Yes
• muting, 4 sensor-parallel	Yes
• muting, 4 sensor-sequential	Yes
• Monitoring parameterizable	Yes
• evaluation: electro-sensitive protective equipment	Yes
• evaluation: selector switch	Yes
• Pressure-sensitive mat monitoring	Yes
• evaluation: two-hand operator panel	Yes

• evaluation: enabling switch	Yes
• monitored start-up	Yes
• two-hand control acc. to EN 574	Yes
<b>Configuration software required</b>	Yes; Safety ES V1.0 and higher
<b>Number of function blocks typical</b>	50
Insulation voltage rated value	50 V
<b>Degree of pollution</b>	3
<b>Surge voltage resistance rated value</b>	800 V
<b>Protection class IP</b>	IP20
• of the enclosure	IP20
• of the terminal	IP20
<b>Shock resistance</b>	15g / 11 ms
Vibration resistance acc. to IEC 60068-2-6	5 ... 500 Hz: 0.75 mm
<b>Product function suitable for AS-i Power24V</b>	No
<b>Product function Diagnostics with CTT2 slave</b>	No
Protocol is supported ASIsafe (Safety at work) protocol	No
<b>Suitability for use</b>	
• Monitoring of floating sensors	Yes
• Monitoring of non-floating sensors	Yes
• position switch monitoring	Yes
• EMERGENCY-OFF circuit monitoring	Yes
• valve monitoring	Yes
• opto-electronic protection device monitoring	Yes
• magnetically operated switch monitoring	Yes
• proximity switch monitoring	Yes
• safety-related circuits	Yes
<b>Suitability for use for monitoring of optoelectronic protective devices acc. to IEC 61496-1</b>	Yes
Operating power rated value	4.5 W

#### Communication/ Protocol

<b>Protocol optional is supported PROFIBUS DP protocol</b>	Yes; when using the DP interface module; 64 bit cyclical data
Protocol is supported AS-interface protocol	No
<b>Amount of data of the cyclic user data</b>	
• for inputs with PROFIBUS DP	64 bit
• for outputs with PROFIBUS DP	64 bit

#### Control circuit/ Control

<b>Type of voltage</b>	DC
<b>Type of voltage of the control supply voltage</b>	DC
<b>Control supply voltage rated value</b>	24 V
Control supply voltage 1 at DC rated value	24 V

<b>Inrush current peak</b> • at 24 V	11 A
<b>Duration of inrush current peak</b> • at 24 V	1 ms
<b>Consumed current for rated value of supply voltage without semiconductor output</b>	185 mA

Inputs/ Outputs	
<b>Product function</b>	
• Parameterizable inputs	Yes
• Parameterizable outputs	Yes
• at the digital outputs Short-circuit protection	Yes
<b>Number of inputs</b>	
• safety-related	20
• non-safety-related	0
<b>Input delay time</b>	0 ... 150 ms
<b>Type of digital inputs acc. to IEC 60947-1</b>	Type 1
<b>Input recording time at digital input maximum</b>	60 ms
<b>Input voltage at digital input</b>	
• at DC rated value	24 V
• with signal <0> at DC	-3 ... +5 V
• for signal <1> at DC	15 ... 30
<b>Input current at digital input</b>	
• for signal <1> typical	2.6 mA
<b>Number of outputs</b>	
• safety-related 2-channel	4
• for testing contact-based sensors	4
<b>Number of outputs as contact-affected switching element safety-related</b>	
• 1-channel	0
• 2-channel	0
<b>Number of outputs as contact-less semiconductor switching element</b>	
• safety-related 2-channel	4
• non-safety-related 2-channel	2
<b>Design of the contactless switching element safety-related</b>	P potential
<b>Recovery time of the safe outputs</b>	0 ms
<b>Readback time maximum</b>	400 ms
<b>Light test period</b>	3 ms
<b>Switching capacity current of semiconductor outputs at DC-13 at 24 V</b>	4 A
<b>Residual current</b>	
• maximum	0.05 mA

<ul style="list-style-type: none"> <li>• at digital output with signal &lt;0&gt; maximum</li> </ul>	0.1 mA
<b>Total current maximum</b>	7 A
<b>Voltage drop maximum</b>	0.5 V
<b>Wire length of the signal cable</b>	
<ul style="list-style-type: none"> <li>• to the inputs <ul style="list-style-type: none"> <li>— shielded maximum</li> <li>— unshielded maximum</li> </ul> </li> <li>• to the outputs <ul style="list-style-type: none"> <li>— shielded maximum</li> <li>— unshielded maximum</li> </ul> </li> </ul>	1 000 m 600 m  1 000 m 600 m

### Installation/ mounting/ dimensions

<b>Mounting position</b>	any
<b>Mounting type</b>	Snap-mounted to DIN rail or screw-mounted with additional push-in lug
<b>Height</b>	100 mm
<b>Width</b>	45 mm
<b>Depth</b>	124.5 mm

### Connections/Terminals

<b>Product function</b>	
<ul style="list-style-type: none"> <li>• removable terminal</li> <li>• removable terminal for control circuit</li> <li>• removable terminal for auxiliary and control circuit</li> </ul>	Yes Yes Yes
<b>Type of electrical connection</b>	screw-type terminals
<ul style="list-style-type: none"> <li>• for auxiliary and control current circuit</li> </ul>	screw-type terminals
<b>Type of connectable conductor cross-sections</b>	
<ul style="list-style-type: none"> <li>• solid</li> <li>• finely stranded with core end processing</li> <li>• at AWG conductors solid</li> <li>• at AWG conductors stranded</li> </ul>	1x (0.5 ... 2.5 mm <sup>2</sup> ), 2x (1.0 ... 1.5 mm <sup>2</sup> ) 1x (0.5 ... 2.5 mm <sup>2</sup> ), 2x (0.5 ... 1.0 mm <sup>2</sup> ) 1x (20 ... 14), 2x (18 ... 16) 1x (20 ... 14), 2x (18 ... 16)
Connectable conductor cross-section finely stranded with core end processing	0.5 ... 2.5 mm <sup>2</sup>
<b>AWG number as coded connectable conductor cross section</b>	
<ul style="list-style-type: none"> <li>• solid</li> <li>• stranded</li> </ul>	20 ... 14 20 ... 14

### Safety related data

<b>Safety Integrity Level (SIL) acc. to IEC 61508</b>	3
<b>SIL Claim Limit (subsystem) acc. to EN 62061</b>	3
<b>Performance level (PL) acc. to EN ISO 13849-1</b>	e
<b>Category acc. to EN ISO 13849-1</b>	4
<b>Stop category acc. to DIN EN 60204-1</b>	0 / 1

Diagnostics test interval by internal test function maximum	1 000 000 ms
PFHD with high demand rate acc. to EN 62061	0.000000012 1/h
PFDavg with low demand rate acc. to IEC 61508	0.000018
MTBF	90 y
Hardware fault tolerance acc. to IEC 61508	1
T1 value for proof test interval or service life acc. to IEC 61508	20 y
Protection against electrical shock	finger-safe





### Electromagnetic compatibility

EMC emitted interference acc. to IEC 60947-1	class A
<b>Conducted interference</b>	
<ul style="list-style-type: none"> <li>due to burst acc. to IEC 61000-4-4</li> </ul>	2 kV (power ports) / 1 kV (signal ports)
Field-bound parasitic coupling acc. to IEC 61000-4-3	10 V/m
Electrostatic discharge acc. to IEC 61000-4-2	4 kV contact discharge / 8 kV air discharge

### Ambient conditions

Installation altitude at height above sea level maximum	2 000 m
<b>Ambient temperature</b>	
<ul style="list-style-type: none"> <li>during operation</li> <li>during storage</li> <li>during transport</li> </ul>	-25 ... +60 °C -40 ... +80 °C -40 ... +80 °C
Air pressure acc. to SN 31205	90 ... 106 kPa

### Certificates/approvals

General Product Approval	Functional Safety/Safety of Machinery	Declaration of Conformity	other
			
	<a href="#">Type Examination Certificate</a>		<a href="#">Confirmation</a>

### Further information

**Information- and Downloadcenter (Catalogs, Brochures,...)**

<http://www.siemens.com/industrial-controls/catalogs>

**Industry Mall (Online ordering system)**

<https://mall.industry.siemens.com/mall/en/en/Catalog/product?mlfb=3SK2122-1AA10>

**Cax online generator**

<http://support.automation.siemens.com/WW/CAXorder/default.aspx?lang=en&mlfb=3SK2122-1AA10>

**Service&Support (Manuals, Certificates, Characteristics, FAQs,...)**

<https://support.industry.siemens.com/cs/ww/en/ps/3SK2122-1AA10>

**Image database (product images, 2D dimension drawings, 3D models, device circuit diagrams, EPLAN macros, ...)**

[http://www.automation.siemens.com/bilddb/cax\\_de.aspx?mlfb=3SK2122-1AA10&lang=en](http://www.automation.siemens.com/bilddb/cax_de.aspx?mlfb=3SK2122-1AA10&lang=en)

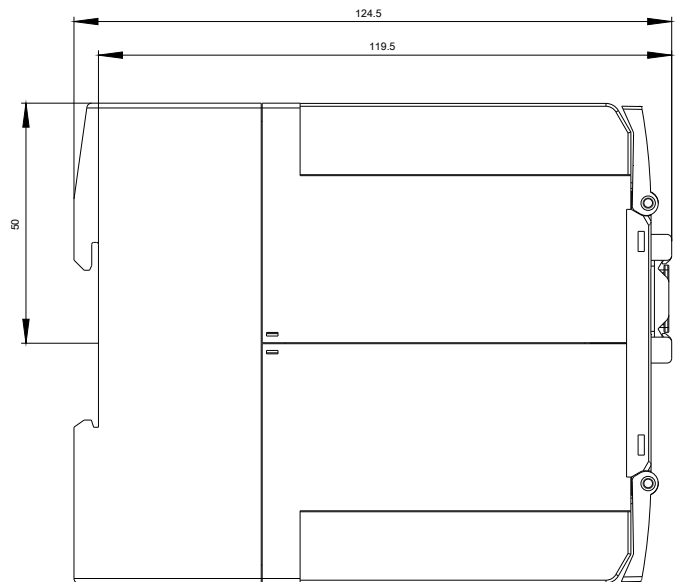
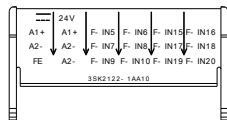
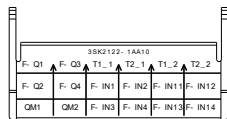
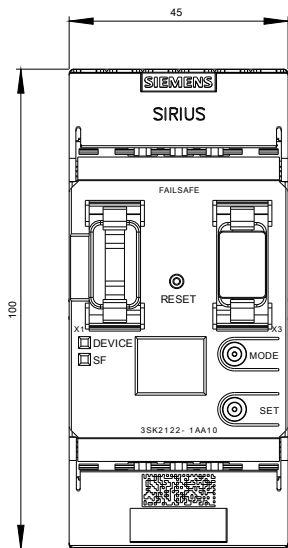

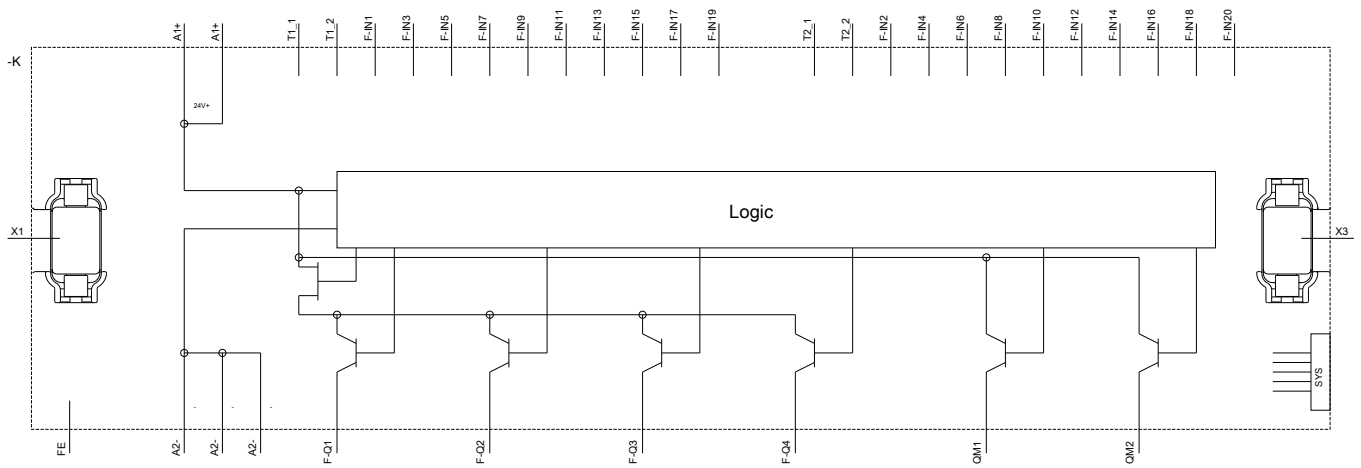

last modified:

06/28/2018