

SIRIUS safety relay Basic unit 3SK2 series 20 F-DI, 4 F-DQ, 2 DQ, 24 V DC Can be parameterized via SIRIUS Safety ES 45 mm overall width Spring-type terminal (push-in) up to SILCL 3 (DIN EN 62061) Up to Performance Level E (ISO 13849-1) Output expansions 3SK1 and fail-safe motor starters 3RM1 via device connector connectable

Product brand name	SIRIUS
Product category	Safety relay
Product designation	Base-Unit

General technical data

Product function	
<ul style="list-style-type: none"> • EMERGENCY STOP function • protective door monitoring • protective door monitoring with tumbler • muting, 2 sensor-parallel • muting, 4 sensor-parallel • muting, 4 sensor-sequential • Monitoring parameterizable • evaluation: electro-sensitive protective equipment • evaluation: selector switch • Pressure-sensitive mat monitoring • evaluation: two-hand operator panel • evaluation: enabling switch • monitored start-up • two-hand control acc. to EN 574 	<ul style="list-style-type: none"> Yes Yes Yes Yes Yes Yes Yes Yes Yes Yes Yes Yes Yes Yes Yes
Configuration software required	Yes; Safety ES V1.0 and higher
Number of function blocks typical	50
Insulation voltage rated value	50 V
Degree of pollution	3
Surge voltage resistance rated value	800 V
Protection class IP	IP20
<ul style="list-style-type: none"> • of the enclosure • of the terminal 	<ul style="list-style-type: none"> IP20 IP20
Shock resistance	15g / 11 ms
Vibration resistance acc. to IEC 60068-2-6	5 ... 500 Hz: 0.75 mm
Product function suitable for AS-i Power24V	No
Product function Diagnostics with CTT2 slave	No

Protocol is supported ASIsafe (Safety at work) protocol	No
Suitability for use	
• Monitoring of floating sensors	Yes
• Monitoring of non-floating sensors	Yes
• position switch monitoring	Yes
• EMERGENCY-OFF circuit monitoring	Yes
• valve monitoring	Yes
• opto-electronic protection device monitoring	Yes
• magnetically operated switch monitoring	Yes
• proximity switch monitoring	Yes
• safety-related circuits	Yes
Suitability for use for monitoring of optoelectronic protective devices acc. to IEC 61496-1	Yes
Operating power rated value	4.5 W

Communication/ Protocol

Protocol optional is supported PROFIBUS DP protocol	Yes; when using the DP interface module; 64 bit cyclical data
Protocol is supported AS-interface protocol	No
Amount of data of the cyclic user data	
• for inputs with PROFIBUS DP	64 bit
• for outputs with PROFIBUS DP	64 bit

Control circuit/ Control

Type of voltage	DC
Type of voltage of the control supply voltage	DC
Control supply voltage rated value	24 V
Control supply voltage 1 at DC rated value	24 V
Inrush current peak	
• at 24 V	11 A
Duration of inrush current peak	
• at 24 V	1 ms
Consumed current for rated value of supply voltage without semiconductor output	185 mA

Inputs/ Outputs

Product function	
• Parameterizable inputs	Yes
• Parameterizable outputs	Yes
• at the digital outputs Short-circuit protection	Yes
Number of inputs	
• safety-related	20
• non-safety-related	0
Input delay time	0 ... 150 ms

Type of digital inputs acc. to IEC 60947-1	Type 1
Input recording time at digital input maximum	60 ms
Input voltage at digital input	
• at DC rated value	24 V
• with signal <0> at DC	-3 ... +5 V
• for signal <1> at DC	15 ... 30
Input current at digital input	
• for signal <1> typical	2.6 mA
Number of outputs	
• safety-related 2-channel	4
• for testing contact-based sensors	4
Number of outputs as contact-affected switching element safety-related	
• 1-channel	0
• 2-channel	0
Number of outputs as contact-less semiconductor switching element	
• safety-related 2-channel	4
• non-safety-related 2-channel	2
Design of the contactless switching element safety-related	P potential
Recovery time of the safe outputs	0 ms
Readback time maximum	400 ms
Light test period	3 ms
Switching capacity current of semiconductor outputs at DC-13 at 24 V	4 A
Residual current	
• maximum	0.05 mA
• at digital output with signal <0> maximum	0.1 mA
Total current maximum	7 A
Voltage drop maximum	0.5 V
Wire length of the signal cable	
• to the inputs	
— shielded maximum	1 000 m
— unshielded maximum	600 m
• to the outputs	
— shielded maximum	1 000 m
— unshielded maximum	600 m
Installation/ mounting/ dimensions	
Mounting position	any
Mounting type	Snap-mounted to DIN rail or screw-mounted with additional push-in lug
Height	100 mm

Width	45 mm
Depth	124.5 mm

Connections/Terminals

Product function	
<ul style="list-style-type: none"> removable terminal 	Yes
<ul style="list-style-type: none"> removable terminal for control circuit 	Yes
<ul style="list-style-type: none"> removable terminal for auxiliary and control circuit 	Yes
Type of electrical connection	Push-in terminal
<ul style="list-style-type: none"> for auxiliary and control current circuit 	spring-loaded terminals
Type of connectable conductor cross-sections	
<ul style="list-style-type: none"> solid 	1x (0.5 ... 1.5 mm ²), 2x (0.5 ... 1.5 mm ²)
<ul style="list-style-type: none"> finely stranded with core end processing 	1x (0.5 ... 1.0 mm ²), 2x (0.5 ... 1.0 mm ²)
<ul style="list-style-type: none"> at AWG conductors solid 	1x (20 ... 16), 2x (20 ... 16)
<ul style="list-style-type: none"> at AWG conductors stranded 	1x (20 ... 16), 2x (20 ... 16)
Connectable conductor cross-section finely stranded with core end processing	0.5 ... 1 mm ²
AWG number as coded connectable conductor cross section	
<ul style="list-style-type: none"> solid 	20 ... 16
<ul style="list-style-type: none"> stranded 	20 ... 16

Safety related data

Safety Integrity Level (SIL) acc. to IEC 61508	3
SIL Claim Limit (subsystem) acc. to EN 62061	3
Performance level (PL) acc. to EN ISO 13849-1	e
Category acc. to EN ISO 13849-1	4
Stop category acc. to DIN EN 60204-1	0 / 1
Diagnostics test interval by internal test function maximum	1 000 000 ms
PFHD with high demand rate acc. to EN 62061	0.000000012 1/h
PFDavg with low demand rate acc. to IEC 61508	0.000018
MTBF	90 y
Hardware fault tolerance acc. to IEC 61508	1
T1 value for proof test interval or service life acc. to IEC 61508	20 y
Protection against electrical shock	finger-safe





Electromagnetic compatibility

EMC emitted interference acc. to IEC 60947-1	class A
Conducted interference	
<ul style="list-style-type: none"> due to burst acc. to IEC 61000-4-4 	2 kV (power ports) / 1 kV (signal ports)
Field-bound parasitic coupling acc. to IEC 61000-4-3	10 V/m
Electrostatic discharge acc. to IEC 61000-4-2	4 kV contact discharge / 8 kV air discharge

Ambient conditions

Installation altitude at height above sea level maximum	2 000 m
Ambient temperature	
• during operation	-25 ... +60 °C
• during storage	-40 ... +80 °C
• during transport	-40 ... +80 °C
Air pressure acc. to SN 31205	90 ... 106 kPa

Certificates/approvals

General Product Approval	Functional Safety/Safety of Machinery	Declaration of Conformity	other		
 CSA	 UL		 Type Examination Certificate	 EG-Konf.	Confirmation

Further information

Information- and Downloadcenter (Catalogs, Brochures,...)

<http://www.siemens.com/industrial-controls/catalogs>

Industry Mall (Online ordering system)

<https://mall.industry.siemens.com/mall/en/en/Catalog/product?mlfb=3SK2122-2AA10>

Cax online generator

<http://support.automation.siemens.com/WW/CAXorder/default.aspx?lang=en&mlfb=3SK2122-2AA10>

Service&Support (Manuals, Certificates, Characteristics, FAQs,...)

<https://support.industry.siemens.com/cs/ww/en/ps/3SK2122-2AA10>

Image database (product images, 2D dimension drawings, 3D models, device circuit diagrams, EPLAN macros, ...)

http://www.automation.siemens.com/bilddb/cax_de.aspx?mlfb=3SK2122-2AA10&lang=en

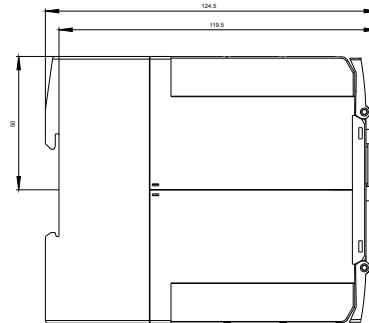
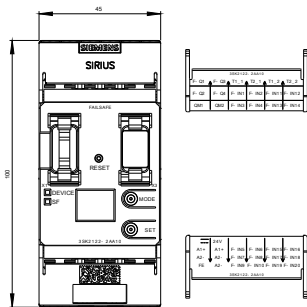

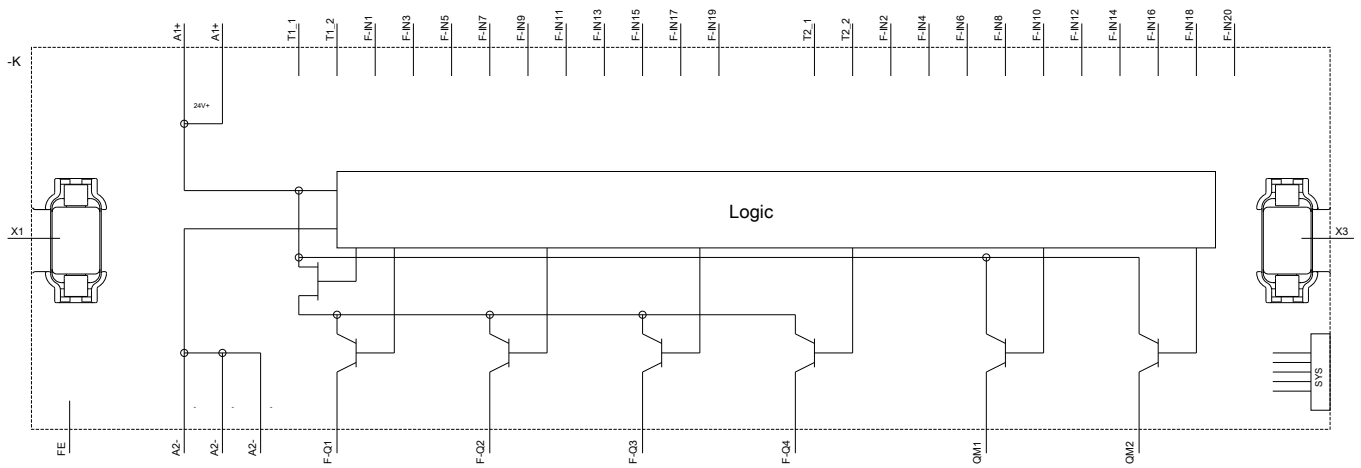

last modified:

06/28/2018